

**AKAI** | Powered by **Tizen®**

55" Ultra HD  
Smart TV

MODEL: AK5522S7TZN

User Manual



# Welcome

Congratulations on your purchase!

This manual tells you all you need to know about using your new AKAI product.

Please take special note of any important safety and usage information presented with the  symbol.

All products brought to you by AKAI are manufactured to the highest standards of performance and safety and, as part of our philosophy of customer service and satisfaction, are backed by our comprehensive 3 Year Warranty.

We hope you will enjoy using your purchase for many years to come.

Welcome	2	On-Screen Set Up	16	Troubleshooting	33
Unpack and Prepare	4	Displaying Your Smart Phone Screen To The TV	17	Specifications	36
What's in the Box	4	Displaying Your PC Screen To The TV	17	Compliance and Responsible Disposal	37
 Important Tips	5	Control The TV With A Keyboard, Mouse or Gamepad	17		
Attaching the Stand	6	Using The Keyboard And Mouse	18		
Wall-Mounting the TV	7	Smart TV	19		
Connect to Power	8	Smart Hub	19		
Connect your Antenna	8	Using the On-Screen Virtual Keyboard	20		
Controls and Connections	9	Home Screen	21		
Get to Know your TV	9	Samsung Account	23		
Buttons on the TV	9	Using the Apps Service	24		
Ports on the TV	10	Using the e-Manual	25		
Remote Control	12	System and Support	26		
Setup	12	High Dynamic Range (HDR)	30		
Using the Remote Control	13	TV Guide	31		
Remote Pairing	13				
Smart Remote	14				
Pairing the Remote	15				
Using Voice Assistant	15				

# Unpack and Prepare

## What's in the box

Before installing your new TV, check you have everything needed.

In the box you will find:

- A. 55" Ultra HD Smart TV
- B. Smart Remote
- C. AAA Batteries
- D. TV Stands
- E. Screws for TV Stands
- F. Warning Sheet
- G. TV Toppling Safety Message
- H. Quick Start Guide
- I. Warranty Certificate
- J. General Safety Warnings
- K. User Manual



You will need:

- Phillips-head screwdriver (for stand installation)
- Antenna cable (to watch live TV)
- Someone to help you lift and install your TV
- Broadband internet connection (to use smart apps)

## Important Tips

- Place the TV on a level surface.
- Place the TV away from any source that may generate heat or vibrations.
- Make sure there is enough space around vents for airflow.
- The remote control works up to 5 metres away from the TV.
- Unplug the TV before cleaning it.
- Clean using a dry cloth only - do not use water or chemicals.
- Use only the power supply provided.
- It is highly recommended to use safety straps for securing the TV in place.
- Keep liquid, children and pets away from the TV at all times.

# Attaching the stand

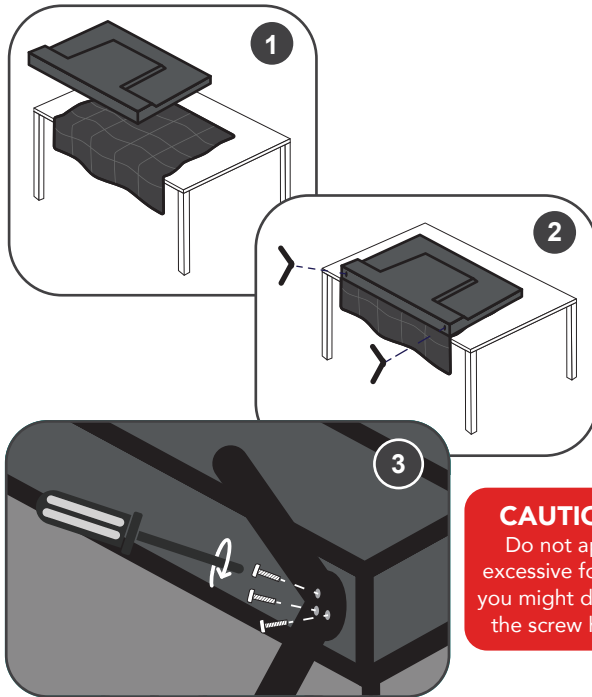

**CAUTION!**  
Do not apply  
excessive force as  
you might damage  
the screw holes.



- This TV is heavy! We recommend asking someone to help you lift it.
- Unplug the TV from the power outlet before installing or removing the stand.
- Only touch the frame, not the screen.
- It is highly recommended to use safety straps for securing the TV.

Unless you are wall-mounting the TV, you will need to attach its stand/legs.

1. Lay the TV face-down on a soft, flat surface (like the sofa, or a towel on a table) larger than the TV itself.
2. Match stands to the installation points on the underside of the TV.
3. Attach the stands to the TV at the installation points using the screws provided. (Grab a screwdriver for this bit). Make sure the legs are facing away from each other (not leaning inwards).

# Wall-mounting the TV



- Unplug the TV from the power outlet before wall-mounting.
- Contact a professional for assistance with wall-mounting the TV.

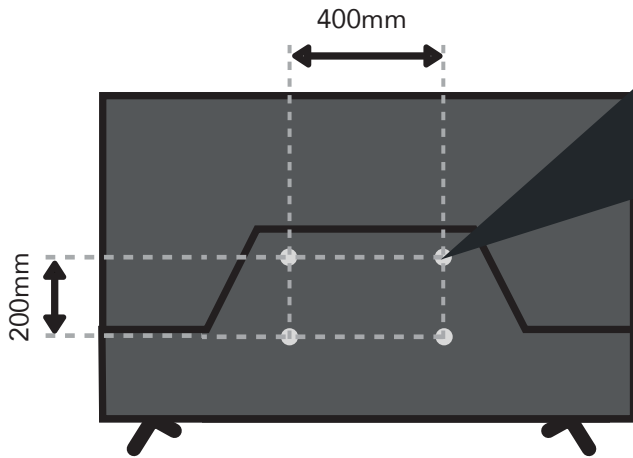

Back of the TV

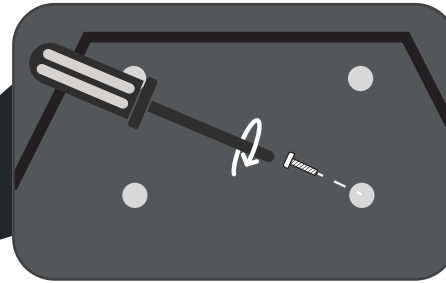

## Required

- VESA Mounting Bracket
- 4 x M6\*10mm screws (or longer as required)

The TV comes with holes on the back panel for use with wall-mounting brackets (bracket not included).

Use four standard M6\*10mm screws (or longer, depending on the mounting bracket) to wall-mount this TV (screws are not included).



The screws in the package are for securing the TV stand only. If you are wall-mounting the TV, consult a qualified installer for advice on bracket support and wall support.

## Connect to power

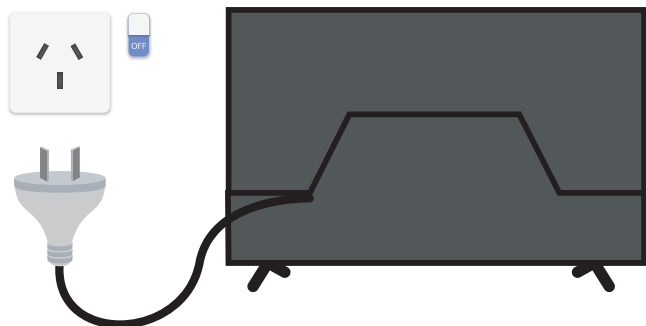

Don't forget to plug in the TV to the power outlet. Leave the power switched off until installation is finished.



Make sure the TV is **switched off** at the power outlet until you have finished connecting your cables.

## Connect your antenna

Free-to-air TV in HD (High Definition)

Example  
HD Channels

ABC HD  
SBS ONE HD  
7HD  
9HD  
10 HD  
PRIME7 HD  
WIN HD

High Definition (HD) channels provide the best viewing quality and are available with a digital antenna connection.

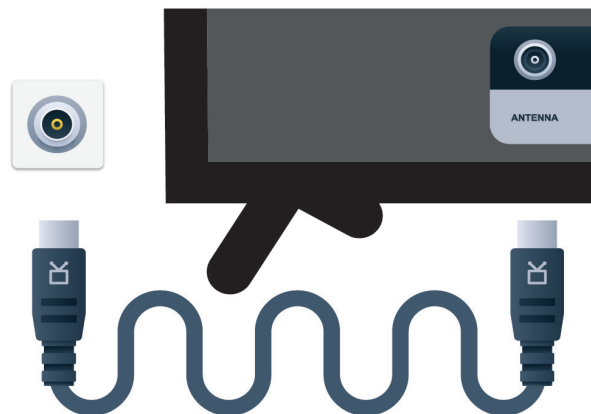

Antenna cable not included.





# Controls and Connections

## Get to know your TV



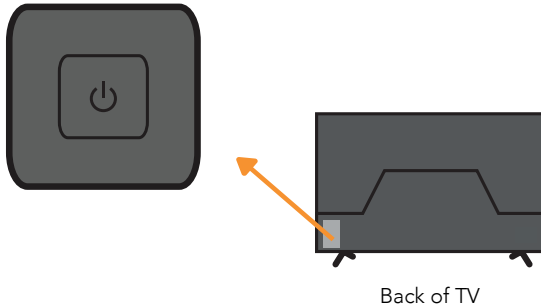





## Buttons on the TV

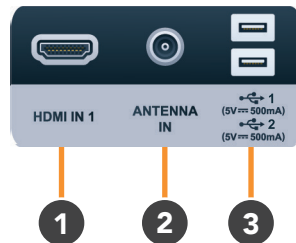
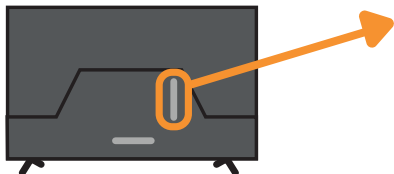







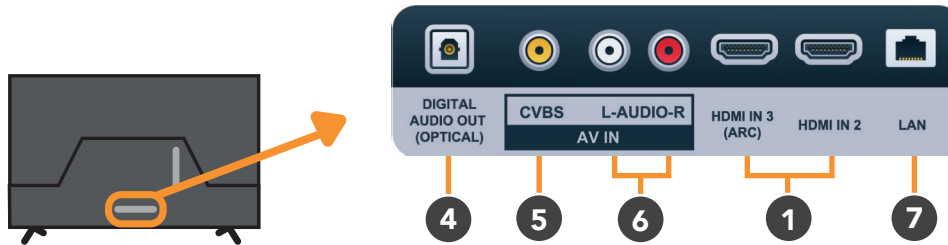

-  (On/Standby) : When the TV is off, press this button to turn the TV on.
- When the TV is on, press once to access the on-screen control menu.
- While on this menu, press once to switch between menu options; press and hold for 1.5 seconds to select.

# Ports on the TV



1	<p><b>HDMI IN</b></p> <p>Use a high-speed HDMI cable for best picture and sound quality.</p>	 	<p>SOUND</p> <p>PICTURE</p> <p>COMPUTER</p>	<p>All-digital connection between the TV and any HDMI device. Supports Ultra HD. Requires a HDMI cable (not included).</p>
2	<p><b>ANTENNA IN</b></p>	 	<p>FREE TO-AIR</p> <p>TV</p>	<p>Connect your antenna for live TV. (Antenna cable not included).</p>
3	<p><b>USB</b></p>	 	<p>STORAGE</p>	<p>Plug in a USB stick/drive to play media files stored on your USB storage device (supported file codecs and extensions may vary).</p>

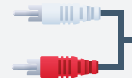

4	DIGITAL AUDIO OUT (OPTICAL)	 	SOUND	Connect an external digital audio device. Use an Optical cable (not included) to connect the unit with an amplifier, soundbar or other audio decoding device for digital audio signal output.
5	AV IN (CVBS)	 	PICTURE	You can use this to connect your DVD player. Supports Standard Definition (SD) picture quality. Requires an AV cable (not included).
6	AUDIO IN	 	SOUND	You can use this to connect Audio to your TV for AV or Component video inputs. Requires an AV cable (not included).
7	LAN	 	INTERNET	Connect to your broadband modem using an Ethernet cable (not included).

# Remote Control

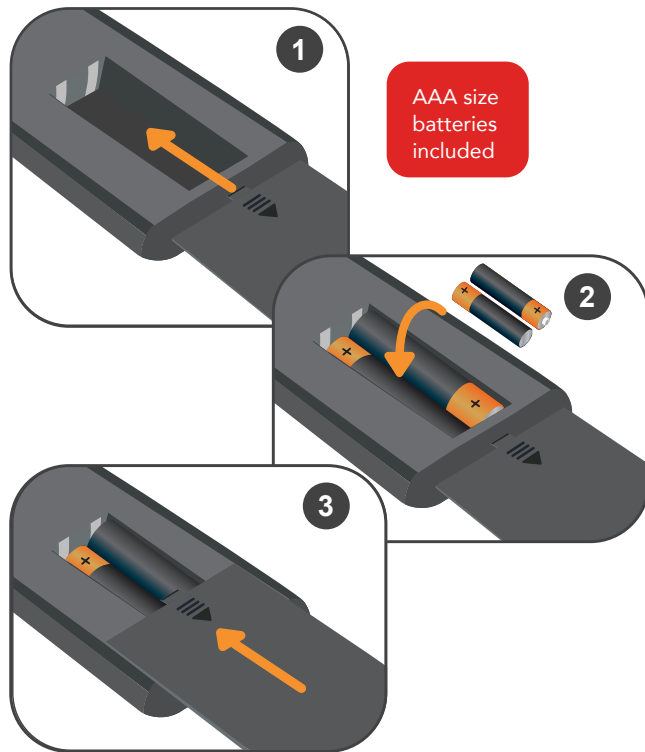

Image is for illustration purposes only. Position of battery cover/clip and polarities of batteries on your remote control may vary.

## Setup

Insert two AAA size batteries according to the polarity markings (+ / -) inside the compartment. Make sure the batteries are correctly aligned and properly pushed into place.



### Precautions When Using Batteries

- Do not use old and new batteries together.
- Do not use different types of batteries (e.g. Manganese and Alkaline batteries) together.
- Remove the batteries from the remote if you do not intend to use it for a long time.
- When discarding used batteries, follow any guidelines for recycling and disposal of batteries that apply in your local area.
- Keep batteries away from children and pets.
- Never throw batteries into a fire or expose them to extreme heat.

# Using the Remote Control

To use the remote, point it towards the remote sensor at the front of the TV. The remote will not operate if its path is blocked.

The remote has a range of up to about 5 metres from the TV at an angle of up to 30 degrees to either side of the sensor, as illustrated below.

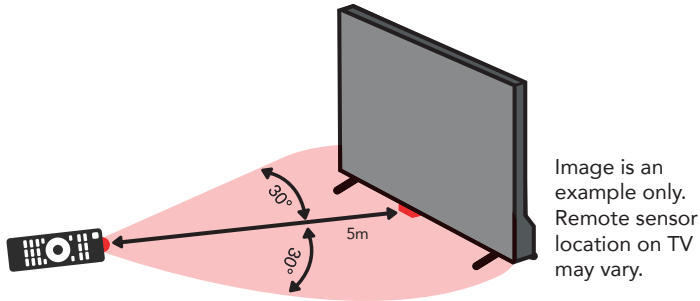

## Remote Hints and Tips

- Do not drop, step on or otherwise impact the remote control. This may damage the parts or lead to malfunction.
- Do not place objects between the remote control and the remote sensor.
- Do not use this remote control while simultaneously operating a remote control for other devices.

## Remote Pairing

This remote control uses both Bluetooth® and IR (infrared) to send its commands to the TV.

- You can use this remote control via IR for most operations.
- To use advanced operations like voice search, you need to pair the TV with the remote control. See page 15 for more information on pairing your remote.

# Smart Remote



Microphone

**(POWER)**: Press to turn the TV on or off

**NUMBER BUTTONS**: Press to bring up the virtual numeric pad on the screen. Use the numeric keypad to enter numeric values. Select numbers and then select Done to enter a numeric value. Use to change the channel, enter a PIN etc.

: Press and hold the button, speak a command then release the button to run Voice Assistant.

**/ RETURN** : Press to return to the previous menu. Press when watching a channel to return to the previous channel

: Move the button up or down to adjust the volume. Press to mute/unmute. Press and hold to directly go to accessibility shortcuts

**NETFLIX** : Launch the Netflix app

**prime video** : Launch the Amazon Prime Video app

**RED/GREEN/YELLOW/BLUE**: Press the button to run the additional option for the current function

**UP/DOWN/LEFT/RIGHT** : Press the **UP/DOWN/LEFT/RIGHT** buttons to navigate the menu or move the focus to highlight items on the Home Screen

**SELECT**: selects or runs a focused item. When pressed while you are watching a broadcast program, detailed program information appears

: Press to display playback controls. Use these to control the media content that is playing

: Go to return to the Home Screen



: Move the button up or down to change the channel. Press to access DTV guide. Press and hold to display channel list

**Samsung TV Plus** : Launch the Samsung TV Plus service



AKAI



## Pairing the Remote

When you turn the TV on for the first time, the Smart Remote will pair with the TV automatically. If it does not pair, point the remote towards the TV sensor and press the  / RETURN and  buttons simultaneously for 3 seconds.



## Using Voice Assistant



Press and hold the  button on the remote, say a command then release the  button. The TV will recognise the voice command (i.e. say "volume up" and the TV will increase the volume setting accordingly).

Note: Voice Assistant is available only when the TV is connected to the internet.

You must also:

- Agree to Smart Hub's Terms Of Use
- Agree to a guidance regarding the collection and use of personal information of the Smart Hub Service
- Consent to the collection and use of personal information for the voice interaction-based service

# On-Screen Set Up



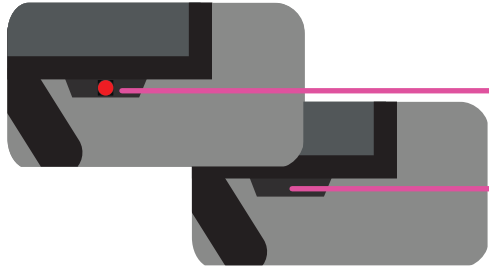

Make sure equipment is properly connected (as shown on pages 10-11) before connecting the TV to power.

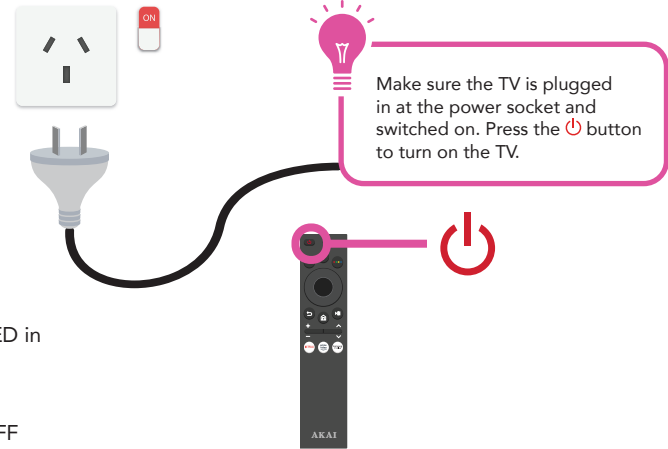

On/Standby light is RED in standby mode.

On/Standby light is OFF when the TV is on.



Make sure the TV is plugged in at the power socket and switched on. Press the  button to turn on the TV.

## First Time Setup menu

When you turn the TV on for the first time, the First Time Setup menu will appear.

Follow the prompts using the **▲ / ▼ / ◀ / ▶ / OK** buttons to select your preferences. You will be guided through:

1. Language
2. Let's Get Setup
3. Connect Your Devices To The Screen
4. Terr./Cable Signal Detected
5. Terms And Conditions, Privacy Policy
6. Checking For Updates
7. Sign Into Your Samsung Account
8. Select Your TV Source
9. Set Current Time
10. Discover A Faster Way To Link Your Apps
11. Start Watch TV

If you make an error, you can update your preferences in the settings menu later.

If you are using a wired network, connect an ethernet cable to the TV. The TV will automatically connect to the Internet.



If you are using a wireless connection, open "Network Settings" and select "Wireless". The TV will scan for nearby wireless networks. Make sure that the TV is within the range of your wireless modem/router, and you have your Wi-Fi password handy. Select your network, enter network password using the on-screen keyboard and select ENTER. Press OK to connect.

Or, you can connect to the internet later by going to the User Menu settings.



## Displaying Your Smart Phone Screen To The TV



You can watch the screen of your smart phone on the TV screen through Smart View.

Press the  button on the remote >  Source > Press the  button > Select "Connection Guide" > Smartphone > Screen Sharing (Smart View).

- To turn off Screen Sharing (Smart View), disconnect the smart phone or press the  button on the remote control.
- Using the Smart View menu on your smart phone, you can change the settings such as aspect ratio.

## Displaying Your PC Screen To The TV

You can watch your Windows 10 PC screen on the TV screen through Screen Sharing (Wireless).



Press the  button on the remote >  Source > Press the  button > Select "Connection Guide" > PC > Screen Sharing (Wireless).

- On your Windows 10 computer, press the  P and K buttons on your keyboard, and select device name "Tizen Smart TV" to start wireless display.

## Control The TV With A Keyboard, Mouse or Gamepad

You can connect a keyboard, mouse or gamepad to make it easier to control your TV.

Press the  button on the remote >  Settings > General > External Device Manager > Input Device Manager.

- Plug in your keyboard, mouse or gamepad into the USB port on the back of the TV.
- Note: a mouse can only be used on the Internet app.
- You can find more detailed information by referring to  >  Source > Press the  button > Select "Connection Guide" > Input Device.



# Using The Keyboard And Mouse



Button	Function
Directional keys	Moves the focus
Windows key	Displays TV settings
Enter Key	Selects or runs a focused item
F1/F2/F3/F4 key	●●●● buttons
F5 key	Displays the Home Screen
F6 key	Displays the Source Screen
F7 key	Displays the Channel List
F8 key	Mutes the sound
F9/F10 key	Adjust the volume
F11/F12 key	Change channels
Page Up/Down	Scrolls a web page when on the Internet app
Left-click (mouse)	Click a menu or link to start a function (only available when on Internet app)
Right-click (mouse)	Open, open link in new tab, enable scroll mode (only available when on Internet app)



Note: the key operation may differ depending on the app or the keyboard.

# Smart TV

## Smart Hub

On Smart Hub, you can install and use various apps, view photos and videos or listen to music stored on external storage devices.

To use Smart Hub, you must agree to the Smart Hub service agreement and the collection and use of personal information. You cannot use the additional features and services without giving consent. You can view the Terms & Privacy by pressing  >  Settings > Terms & Privacy.

If you want to stop using Smart Hub, you can cancel the agreement. To cancel the Smart Hub service agreement, press  >  Settings > Support > Device Care > Self Diagnosis > Reset Smart Hub.



- Some Smart Hub services are paid services.
- You must be connected to the internet to use Smart Hub.
- Some Smart Hub features may not be supported.



# Using the On-Screen Virtual Keyboard

You can use the built-in virtual keyboard to enter text on your TV.

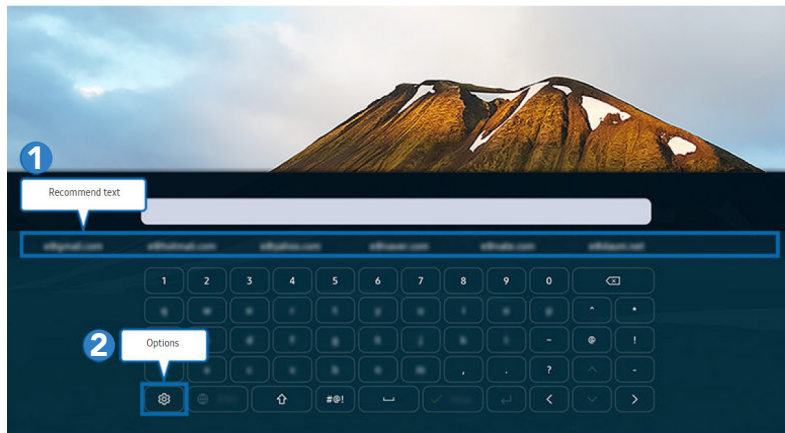



1. Recommend text : the virtual keyboard will automatically generate related suggestions when typing a word.
2. Options: Select  on the screen and the below options can be adjusted:
  - Recommend text
  - Reset recommended text memory
  - Language

 Image is for reference only. The image may differ.

# Home Screen

Press the  button to display the Home Screen, where you can open previously or frequently used apps. You can also move or delete the apps from the screen.

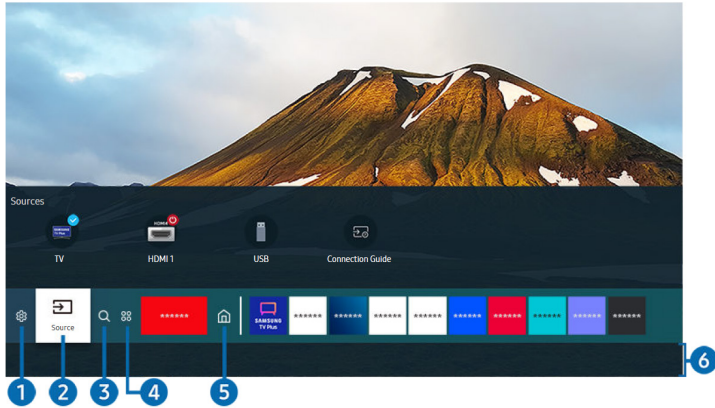











Image is for reference only. The image may differ.

1.  Settings : a list of quick setting icons will appear above the top of the menu. You can set frequently used functions by selecting the icons.
  - e-Manual : read the built-in TV manual. Please refer to page 25 for more detailed information.
  - Picture mode: select picture mode that provides best viewing experience.
  - Sound mode: select a sound mode that best optimises your sound experience.
  - Sound output: select which speakers the TV uses for audio output. Select Bluetooth Speaker List to connect to a Bluetooth speaker.
  - Subtitle: turn subtitles on/off.
  - Audio Language: change the audio language.
  - Sleep Timer: set TV standby sleep timer.
  - Network: View current network and internet status.
  - Device Care: run to diagnose and optimise your TV + TV storage.
  - All Settings: display settings menu.

2.  Source: select an external device connected to the TV.
  - When a USB device is connected to the USB port on the back of the TV, a pop-up will appear allowing you to switch between the media contents on the USB device.
  - Select the connected external device and 2 options will appear:
    1. Browser: browse the media contents on the external device.
    2. Cancel: cancel the pop up screen and return.
3.  Search : search for channels, TV programs, movie titles and apps from Smart Hub.  
Note: you must be connected to the internet to use this feature.
4.  Apps : explore and download your favourite apps, including sports, weather, news and games.  
Note: you must be connected to the internet to use this feature. Please refer to page 24 for more detailed information.
5.  Home : Press the  button on the remote to open the Home menu. Here you can access:
  - Samsung Account: create a new account or sign out of current account.
  - Notification: View list of notifications for all events that occur on the TV. Select  Delete All to delete all notifications. Select  Settings and you can choose the services that you wish to receive notifications on. Select Allow Sound and all incoming notifications will be displayed with a notification sound.
  - Privacy Choices : view and set the privacy policy for Smart Hub and various other services.
6. Move and Remove: Select an app, press the  button on the remote to display the option menu. Select "Move" to shift to the desired position. Select "Remove" to remove it from the home screen.

# Samsung Account

🏠 > ⚙️ Settings > General > System Manager > Samsung Account

Follow the on screen instructions to create, sign in or sign out of a Samsung account.

After logging into your Samsung account, you can view the Terms and Policy by navigating to 🏠 > ⚙️ Settings > General > System Manager > Samsung Account > My Account > Terms & Conditions, Privacy Policy.

Your Samsung account can be used on TV, smart phone and website all within the one account.

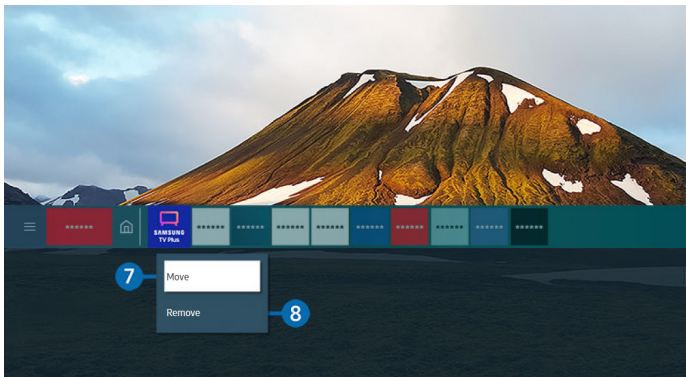

Image is for reference only. The image may differ.

## Launching Smart Hub Automatically

🏠 > ⚙️ Settings > General > Smart Features > Autorun Smart Hub

When you set Autorun Smart Hub to On, the TV displays the Home Screen automatically when you turn the TV on. You can also turn this function off.

## Launching The Last Used App Automatically

🏠 > ⚙️ Settings > General > Smart Features > Autorun Last App

If set to On, the last used app is automatically run when you turn on the TV. You can also turn this function off.

Note: this function may not be supported on all apps.



# Using the Apps Service

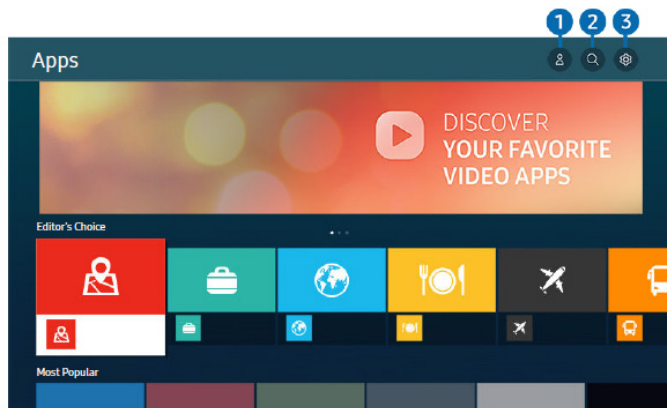

Image is for reference only. The image may differ.



You can download and run various apps such as news, sports, weather and games from the Smart Hub.

When Smart Hub is launched for the first time, the default apps are automatically installed.

1. Samsung Account : create a new account or sign out of the current account. You must be signed into a Samsung Account to download apps.
2. App Search : search for the available apps.
3. ⚙️ Settings : manage the installed apps.

## Installing an App

- When on the app you wish to install, press the Select button.
- Select Install. When the app has been installed, the Open menu will appear.
- Select Open to run the app.

## Managing Installed Apps

Select ⚙️ Settings on the top right corner of the Apps screen to manage your installed apps.

1. Delete : select an app to delete.
2. Add to Home : add an app to the Home Screen.
3. Lock: select an app to lock/unlock. You will need to enter the PIN to lock/unlock the app.
4. Move: select an app to move.
5. Reinstall : reinstall an app.
6. View Details : select to view the app information.



You must be connected to the internet to use this feature.



# Using the e-Manual

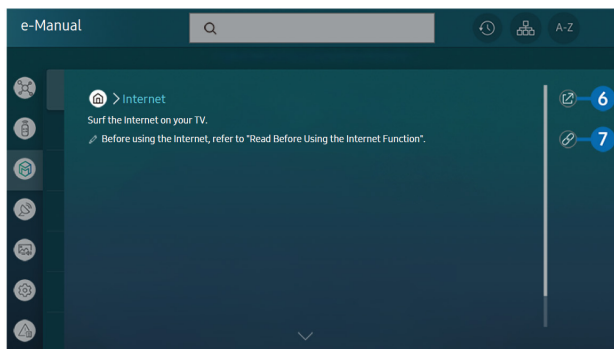
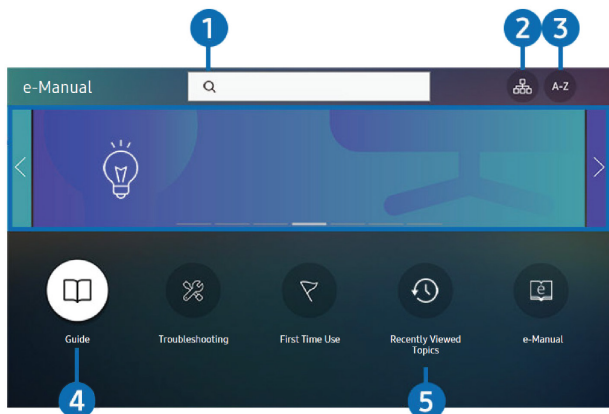

Press > Settings > Support > Open e-Manual to control and read the built-in TV manual.



1. Search : select an item from the search results to load the corresponding page.
2. Site Map : displays the list for each item in the e-Manual.
3. A-Z Index : select a keyword to navigate to the relevant page.
4. Guide : provides instructions on how to use various TV functions.
5. Recently Viewed Topics : select a topic from the list of recently viewed topics.
6. Try Now : allows you to access the corresponding menu item and try out the feature.
7. Link : access an underlined topic referred to on the e-Manual page.

Image is for reference only. The image may differ.

# System and Support

You can configure system and support settings including clock, timers, energy usage and software updates.

## Using the Time Functions and the Timers

- Navigate through  >  Settings > General > System Manager > Time to set the clock manually or automatically. Once the Clock is set, you can view the current time on the TV anytime. You must set the Clock in the below instances:
  - Power cable is disconnected then connected.
  - Clock Mode is changed from Auto to Manual
  - TV is not connected to the Internet
  - No broadcast signals are received.



## Setting the Clock Automatically

- Navigate through  >  Settings > General > System Manager > Time > Clock > Clock Mode > Auto.





You must be connected to the internet or digital broadcasts are received through a connected antenna. The accuracy of the time may differ with the channel and signal.







## Adjusting the Clock for DST and Time Zone

- Navigate through  >  Settings > General > System Manager > Time > Clock > Time Zone to set the correct time (local time zone) or Daylight Savings Time (DST).
- Note: this function is only available when Clock Mode is set to Auto.



## Changing the Current Time

- Navigate through  >  Settings > General > System Manager > Time > Clock > Time Offset to adjust the time through a network connection.
- Note: this function is only available when Clock Mode is set to Auto, and if the TV doesn't receive time data through regular broadcast signals. You must also be connected to internet.



## Setting the Clock Manually

- Navigate through  >  Settings > General > System Manager > Time > Clock > Clock Mode > Manual.
- When Clock Mode is set to Manual, you can directly enter the current date and time. Use the  /  /  /  buttons on the remote to select the Date and Time.



## Using the Sleep Timer

- Navigate through  >  Settings > General > System Manager > Time > Sleep Timer
- Use this function to automatically turn the TV to standby after a pre-set period of time. You can set the sleep timer for up to 180 minutes.

## Turning off the TV using the Off Timer







- Navigate through  >  Settings > General > System Manager > Time > Off Timer
- Set this function to turn the TV to standby at a specific time. This function is only available once the Clock settings has been done.

## Using the Power and Energy Saving Functions

- Navigate through  >  Settings > General > Power and Energy Saving to reduce energy consumption. You can adjust the below:
  - Screen Saver : activate a screensaver when your TV displays a still image for two hours or more.
  - Auto Power Off : automatically turns off the TV to reduce unnecessary power consumption if the TV button and remote control are not used for a set period of time.





## Update the TV's Software

- Navigate through  >  Settings > Support > Software Update to update the TV's software version.
- To update through the Internet, navigate through  >  Settings > Support > Software Update > Update Now.
- To update automatically, navigate through  >  Settings > Support > Software Update > Auto Update, and if the TV is connected to the Internet, the TV's software will automatically update whilst watching TV. If you agree to the Smart Hub's terms and conditions, this Auto Update feature is automatically set to On.



















- **DO NOT** turn off the TV's power until the update is complete. The TV will turn off and on automatically after completing the software update. Video and audio settings will be reset to their default after the software update.

## Using Voice Features





- Navigate through  >  Settings > General > Voice to change the settings of the voice function.
- Note: you must be connected to the internet to use this feature.

## Using Other Features

- Navigate through  >  Settings > General > System Manager > Language to change the menu language of the TV.
- Navigate through  >  Settings > General > System Manager > Change PIN and the PIN input window will appear. Enter a PIN (the default is 0000).
  - On your Smart Remote, press the  /  button >  >  >  >  >  >  (in that order) to reset the PIN.
- Navigate through  >  Settings > General > External Device Manager > Device Connection Manager to manage connected external devices such as mobile devices and tablets.
  - Access Notification : set whether to display a notification when an external device such as a mobile device or tablet attempts to connect to the TV.
  - Device List : manage the list of external devices registered to the TV.

- Navigate through  >  Settings > General > Reset to restore all TV settings back to factory default.
  1. Select Reset and the security PIN window will appear.
  2. Enter the security PIN and select Reset. All settings are now restored to factory default and the TV will restart and display the initial setup screen.



If you skipped some steps during the initial setup, navigate through  >  Source >  > TV >  > Set Up TV and then configure the settings in the steps you skipped.

# High Dynamic Range (HDR)

## About the HDR feature

High Dynamic Range (HDR) is a picture feature on your TV that attempts to mimic the way visuals are perceived in real life by the human eye.

By using this feature, the TV can reproduce greater dynamic range of luminosity by capturing and then combining several different exposures.

HDR promises better picture quality thanks to brighter, more realistic highlights, more realistic colour and other improvements.

It delivers the look that the filmmakers intended to achieve, showing the hidden areas of dark shadows and sunlight with full clarity, colour and detail.



## HDR on your TV

HDR is supported in HDMI and USB input sources and by Netflix app.

Note: this option is only available if the input signal supports HDR.

# TV Guide

In DTV mode, press the remote's  $\wedge$   $\vee$  button up or down to change the channel. Press the **SELECT** button >  $\blacktriangleleft$  button >  $\blacktriangleright$  button to see an overview of each channel's programs lineup.

You can see the daily program schedules for each broadcast, see program information, choose a program to watch and set up a schedule viewing.



- Press and hold the  $\wedge$  /  $\vee$  buttons on the remote to display channel list.
- Press the  $\wedge$  /  $\vee$  buttons on the remote control to view the Guide while watching TV.
- To view the Guide, you must first set the TV's clock settings, which can be done through  $\text{🏠}$  >  $\text{⚙️}$  Settings > General > System Manager > Time > Clock

Move the focus to the program you desire in the Guide, and press and hold the Select button to use the following functions:

- Schedule Viewing : schedule the viewing of a broadcast scheduled program. See the next page for more detailed information.
- Cancel Scheduled Viewing : cancel the scheduled viewing.
- View Details : see detailed information about the selected program.





## Setting Up Schedule Viewing

- To set up a schedule viewing, you must first set the TV's clock settings, which can be done through  >  Settings > General > System Manager > Time > Clock
-  will appear before the program names that have been set for scheduled viewing.



## Using The Schedule Viewing Options From The Guide Screen

- On the Guide screen, select a program you would like to view, press and hold the Select button, and then select Schedule Viewing in the pop-up menu that appears.



## Using The Schedule Viewing Options While Watching A Program

Whilst watching a program on the TV, press the Select button. The Program info window will appear on screen. Select a program that will be broadcasted using the  /  buttons. Press the Select button, and then select Schedule Viewing to schedule viewing of that program.

## Using Schedule Viewing To View Programs At A Specified Time On A Specified Date





- Navigate from  > Live TV >  button > Schedule Manager > Add Viewing
- To schedule a viewing, set the values for Aerial, Channel, Repeat, Date and Start Time of the broadcast program to view, then select Save.

## Setting The Schedule Viewing Time



- Navigate from  > Live TV >  button > Schedule Manager to change scheduled viewing information or cancel schedule viewings.
- Edit : you can set the start item of a scheduled viewing. If you choose a program from the Guide, the Start Time can be set to up to 10 minutes before the program.
- Delete : you can delete scheduled viewings.
- View Details : view detailed information about the scheduled viewings.



# Troubleshooting

Problem	Solution
The remote control does not work	<ul style="list-style-type: none"><li>Make sure that the batteries are installed with their poles (+/-) in the correct direction.</li><li>Remove any obstacles between the remote control and remote control sensor on the TV.</li><li>Check if the power indicator at the bottom of the TV blinks when you press the remote's power button.</li><li>If it does not, replace the remote control's batteries.</li><li>Try pointing the remote directly at the remote control sensor from 1.5-1.8m away.</li></ul>
The TV won't turn on	<ul style="list-style-type: none"><li>Make sure that the AC power cord is securely plugged into the wall outlet.</li><li>Check the wall outlet is turned on and the power indicator at the bottom of the TV is lit.</li><li>If using a multi-outlet, check if it is working properly. To check whether a power strip is working properly, plug the TV's power plug directly to a wall outlet and observe its operation.</li><li>Try to power on using the power button on the TV.</li></ul>
There is no picture/sound or distorted picture/sound in DTV mode	<ul style="list-style-type: none"><li>Ensure the antenna cable is securely connected to the TV and to the wall outlet.</li><li>Ensure the input source is set to DTV.</li><li>If "No Signal" is displayed, Press the  button &gt;  Setting &gt; Broadcasting &gt; Auto Tuning.</li><li>If some channels are missing, Press the  button &gt;  Setting &gt; Broadcasting &gt; Expert Settings &gt; Manual Scan &gt; Digital Channel Tuning.</li><li>Try a different antenna cable or another TV if possible.</li><li>Move the TV away from electronic equipment or devices that could cause interference.</li><li>Adjust the antenna position.</li><li>If the picture appears fuzzy or blurry, select High Definition (HD) channels or programs.</li></ul>



Problem	Solution
<p>There is no picture/sound or distorted picture/sound from an external device</p>	<p>Ensure that connection to the device is correct and that all cables are fully inserted.</p> <p>Remove and reconnect all cables connected to the TV and the external devices. Try new cables if possible.</p> <p>Restart the connected devices by unplugging each device's power cord and then plugging it in again.</p> <p>If "No Signal" is displayed on the TV, ensure that the correct input source has been selected.</p> <p>When using a 4K playback device, ensure the cable is a High-Speed HDMI cable.</p>
<p>There is no/distorted sound</p>	<p>Ensure the volume is not muted. If it is, press the VOL+ button to restore the sound.</p> <p>Ensure that connection to the external audio device is correct and that all cables are fully inserted.</p> <p>Ensure correct input source and audio settings have been selected on the external audio device.</p> <p>Move the TV away from electronic equipment or devices that could cause interference.</p> <p>When using an external audio device via a HDMI cable, ensure that the device supports HDMI-ARC and, if applicable, the ARC setting is turned On (refer to the connection guide in the user manual of the connected device).</p> <p>When using an external audio device via an optical cable, check that the Menu &gt; Press the  button &gt;  Setting &gt; Sound &gt; Expert Settings &gt; Digital Output Audio Format is set to PCM.</p>
<p>The smart apps are not working properly</p>	<p>Ensure the TV is connected to the Internet.</p> <p>Ensure the TV has a high-speed internet connection to get the best-streaming picture resolution.</p> <p>An unstable internet connection may cause delays or interruptions. In addition, applications may terminate automatically depending on the network environment. If this occurs, check your internet connection and try again.</p>



Problem	Solution
<p>There is no/ intermittent internet</p>	<p>When using Wi-Fi, make sure the Wi-Fi password is entered correctly.</p> <p>Turn off the access point. Wait for 2 minutes and then turn them back on.</p> <p>Ensure that there are no obstacles between the TV and the access point. (The Wi-Fi strength can be decreased by appliances, cordless phones, stone walls/fireplaces, etc.) Reduce interference by not using or turning off other wireless devices.</p> <p>If the Wi-Fi connection fails, connect the TV to the access point via a LAN cable. If the TV can connect via the wired connection, there might be a problem with the Wi-Fi access point. In this case, try using a different access point.</p> <p>When using a LAN cable, use one rated CAT 5 or higher. Make sure it is plugged in at both ends.</p> <p>When using a static IP, ensure network addresses are entered correctly.</p> <p>If the problem persists, contact your Internet Service Provider or modem manufacturer.</p>
<p>USB storage device is not recognised or media files don't play properly</p>	<p>This TV has been tested with the majority of Flash memory-based devices and hard disks (media players with HDD) on the market however, it may not be compatible with certain devices.</p> <p>If the external hard drive has its own power adaptor, use it.</p> <p>Only use a USB storage device formatted in a FAT32 file system provided with the Windows operating system. If it is formatted by a different utility program that is not supported by Windows, it may not be recognised.</p> <p>The TV may not be able to recognise a USB device or read the files if it is connected with a USB extension cable.</p> <p>The files that use an unsupported codec or container will not play on the TV.</p> <p>Some files may not play correctly if there is an error in the content or container.</p> <p>Certain files, depending on how they are encoded, may not play on the TV.</p>



# Specifications

Active screen size (diagonal)	139cm	
Resolution	3840 x 2160	
Refresh rate	60Hz	
Aspect ratio	16:9	
Multimedia playback formats (USB mode)	Music	MP3, WAV, FLAC
	Photo	JPG, BMP, PNG
	Video	AVI, MPEG-1, MPEG-2, MPEG-4, MKV
USB output	DC 5V 500mA	
Power source	AC 100-240V, 50/60Hz	
Power consumption	138W	

Dimensions (W x D x H)		With stand: 1240 x 280 x 770 mm
		Without stand: 1240 x 84 x 724 mm
Weight	Net	12.2 kg
	Gross	17 kg

For Technical and Warranty Support

1300 886 649

[tempo.org/support](http://tempo.org/support)

Distributed by Tempo (Aust) Pty Ltd,

PO Box 132, Frenchs Forest NSW 1640

Note: some media formats are not supported due to licensing issues.

The Bluetooth® word mark and logos are registered trademarks owned by Bluetooth SIG, Inc. and any use of such marks by Hands (IP) Holdings Pty Ltd is under license. Other trademarks and trade names are those of their respective owners.

# Compliance and Responsible Disposal



## Packaging

The packaging of your product has been selected from environmentally friendly materials and can usually be recycled. Please ensure these are disposed of correctly. Plastic wrapping can be a suffocation hazard for babies and young children, please ensure all packaging materials are out of reach and are safely disposed of. Please recycle these materials rather than throwing them away.



## Product

At the end of its working life, do not throw this product out with your household rubbish.

An environmentally friendly method of disposal will ensure that valuable raw materials can be recycled. Electrical and electronic items contain materials and substances which, if handled or disposed of incorrectly, could potentially be hazardous to the environment and human health.



## National Television and Computer Recycling Scheme

The careful disposal of e-waste is important because many televisions and computers contain materials which are hazardous to people and the environment. There are no fees for householders or small businesses disposing of e-waste at a scheme collection service.

Individuals can contact their local council for information on local e-waste management services, find scheme services listed on Planet Ark's website at [www.recyclingnearyou.com.au](http://www.recyclingnearyou.com.au), or call Planet Ark on 1300 733 712.

## Compliance

This product complies with the Australian Safety Standard AS/NZS 62368.1 to ensure the safety of the product.



# Notes

# Notes

## For Technical and Warranty Support



1300 886 649



[akai.com.au](http://akai.com.au)



[tempo.org/support](http://tempo.org/support)



Distributed by Tempo (Aust) Pty Ltd,  
PO Box 132, Frenchs Forest NSW 1640